

3/2 way pressure control valve

type **SPP-1 15 DR** **SPP-2 15 DR**

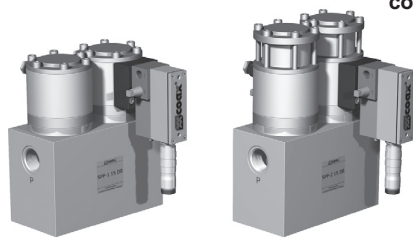

control valve proportional
pressure range PN 0-100 bar
orifice DN 15 mm
connection thread
function stepless pressure regulation

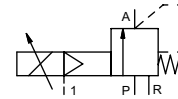

Above stated body materials refer to the valve port connections that get in contact with the media only!

design externally controlled with spring return

body materials ① aluminium ④
① ⑤
③ ⑥

valve seat synthetic resin on metal
seal materials EPDM, PU, HNBR **FPM**

details needed for main valve

- orifice
- port
- pressure regulating range
- flow rate
- media
- media temperature
- ambient temperature

details needed for proportional valve

- nominal voltage
- actuation pressure range min/max

	general specifications	options
ports	SPP threads G 3/4	
function	stepless regulation	
pressure regulation range	bar SPP-1 5-40	SPP-2 5-100
Kv value	m ³ /h max. 6.0	
media	gaseous - liquid	
abrasive media		
flow direction	P: supply pressure A: control pressure R: venting	
operating time	ms < 200	
media temperature	°C 0 to +60	
ambient temperature	°C 0 to +50	
approvals	WAZ	
mounting	mounting bracket	
weight	kg 7,5	7,9
additional equipment		

electrical specifications

	options
nominal voltage	U _B DC 24 V (max. residual ripple 10%)
power consumption	DC < 0,7 A
control signals	U _E 0-10 V (R _e 10KΩ)
protection	IP65 acc. DIN 40 050
energized duty rating	ED 100% (observe the connection conditions accordingly)
connection	plug with 7 contacts / wire diameter 6-8 mm

pneumatic specifications

	options
actuation pressure range	bar see actuation pressure-diagram
air consumption	DIN ISO 8573-1 grade of compressed air quality 5/4/3
control	by 3/2-way proportional valve
actuator ports	1 G 1/8

The valves' technical design is based on media and application requirements. This can lead to deviations from the general specifications shown on the data sheet with regards to the design, sealing materials and characteristics.

If order or application specifications are incomplete or imprecise there exists a risk of an incorrect technical design of the valve for the required application. As a consequence, the physical and / or chemical properties of the materials or seals used, may not be suitable for the intended application.

connection plan

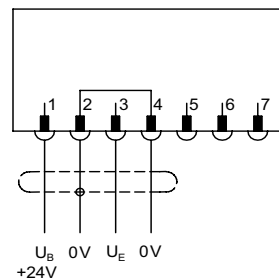

connection conditions

When supplying the electrical set point signal to the proportional valve, the actuating air must already be present. (see actuation pressure-diagram)

position of installation

arbitrarily, but regulator not downwards

■ specifications not highlighted are standard
■ specifications highlighted in grey are optional

type SPP-1 15 DR

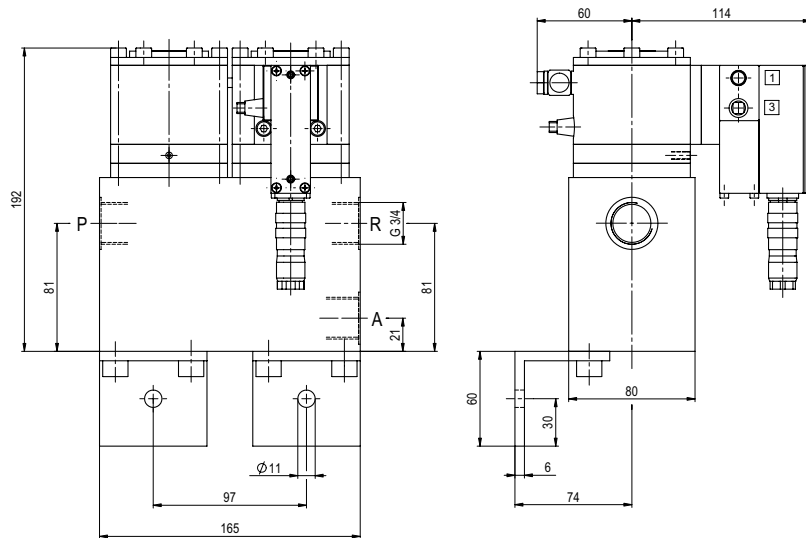

type SPP-2 15 DR

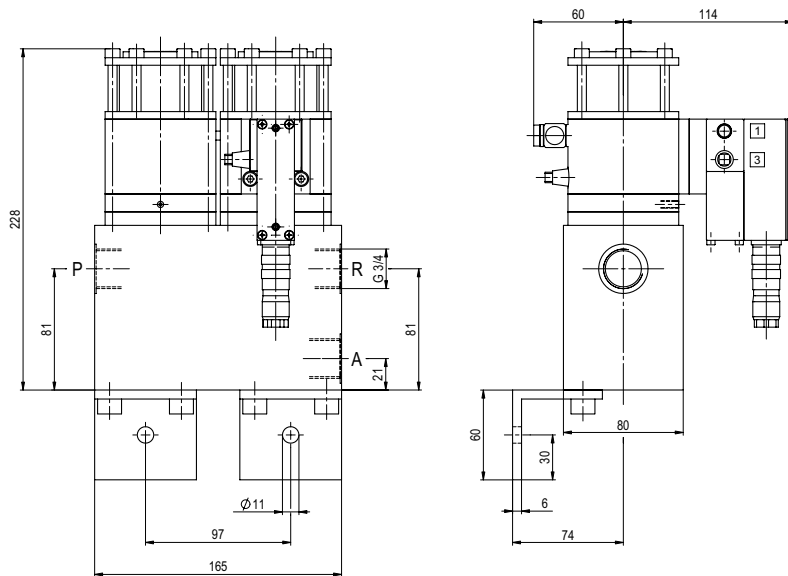

actuation pressure-diagram

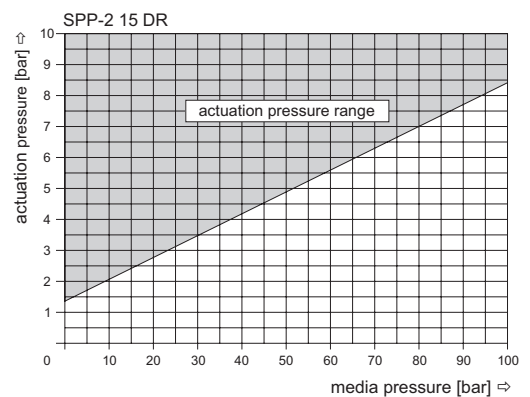
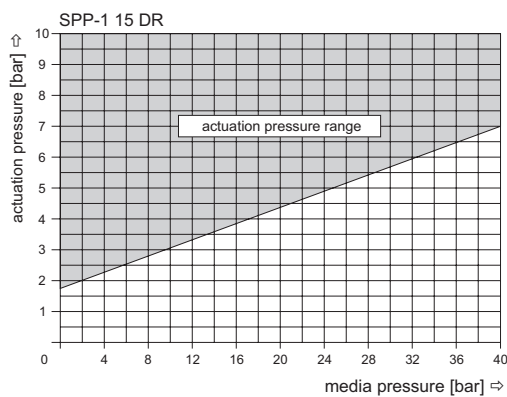

The application-specific layout relating to temperature, pressure conditions, switching behavior, media and its consistency may restrict the range of use or necessitate relevant modifications to materials used and seal arrangements.

Rights reserved to make technical alterations • Not responsible for printing errors • Detailed drawings can be obtained upon request