

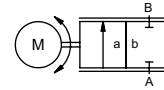

# positioning valve

## type **RMQ 20**



**control valve** electro motorically controlled  
**pressure range** PN 0-64 bar  
**orifice** DN 20 mm  
**connection** thread  
**function** stepless  
 stroke regulation



 Above stated body materials refer to the valve port connections that get in contact with the media only!

**design** direct acting with integrated 3-point-regulation  
**body materials** ① brass ④  
 ② ⑤  
 ③ ⑥ stainless steel  
**valve seat** synthetic resin on metal  
**seal materials** FPM, PTFE

**details needed**

- orifice
- port
- operating pressure/Δp
- flow rate
- media
- media temperature
- ambient temperature
- nominal voltage
- control signal

**general specifications**

**options**

<b>ports</b>	RMQ	threads G 3/4 - G 1
<b>function</b>		stepless regulation
<b>pressure range</b>	bar	0-64
<b>Kv value</b>	DN	20
	m <sup>3</sup> /h	0-7,3
<b>back pressure</b>	bar	max. 10
<b>media</b>		gaseous - liquid - highly viscous - contaminated
<b>abrasive media</b>		version available
<b>flow direction</b>	A ⇌ B	as marked
<b>switching cycles</b>		
<b>operating time</b>	DN	20
<b>closed - open</b>	sec. ca.	3
<b>media temperature</b>	°C	-20 to +80
<b>ambient temperature</b>	°C	max. +70
<b>approvals</b>		WAZ
<b>mounting</b>		mounting bracket
<b>weight</b>	kg	RMQ 5,9

**electrical specifications**

**options**

<b>nominal voltage</b>	U <sub>n</sub>	24 V DC
	U <sub>n</sub>	24 V AC
<b>power consumption</b>	DC	< 0,5 A
	AC	< 0,5 A
<b>control signals</b>	I <sub>e</sub>	0-20 mA / 4-20 mA
	U <sub>E</sub>	0-10 V
<b>protection</b>	IP 65 (P54)	acc. DIN 40 050
<b>energized duty rating</b>	ED	15%
<b>connection</b>	M12x1	concentric socket DIN 40040, 5 poles / wire diameter 6-8 mm
<b>additional equipment</b>		internal separate actual value output

 The valves' technical design is based on media and application requirements. This can lead to deviations from the general specifications shown on the data sheet with regards to the design, sealing materials and characteristics.

 If order or application specifications are incomplete or imprecise there exists a risk of an incorrect technical design of the valve for the required application. As a consequence, the physical and / or chemical properties of the materials or seals used, may not be suitable for the intended application.

■ specifications not highlighted are standard  
 ■ specifications highlighted in grey are optional

# type RMQ 20

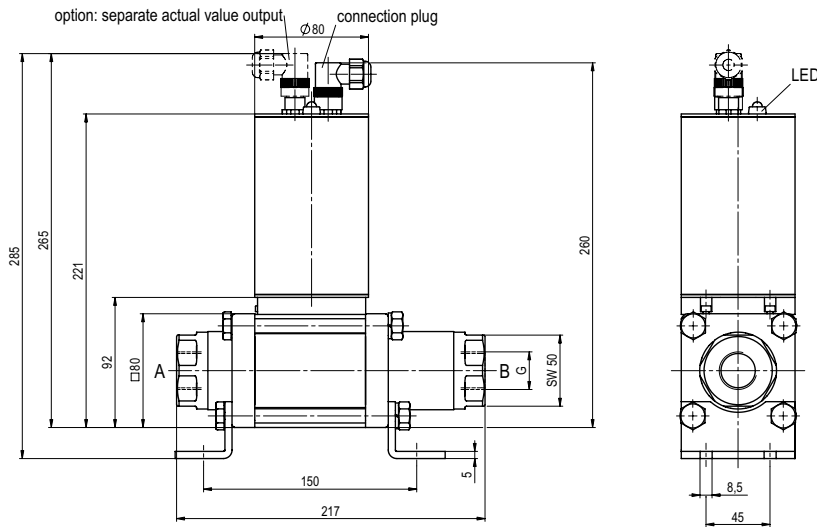

Mounting orientation can be vertical or horizontal, actuator cannot be installed facing down

## kv-value

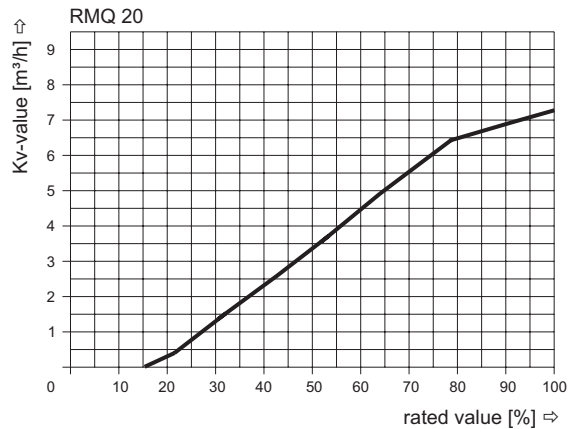

## connection plan / connection plug

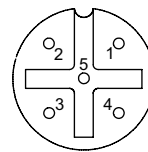

- 1: nominal voltage
- 2: nominal voltage
- 3: control signal
- 4: ground (control signal)
- 5: ⊕

## option separate actual value output

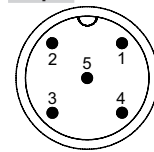

- 1: actual value 4-20 mA (+)
- 2: actual value 4-20 mA (-)