

# lateral valve

## type PCS-3 15

### 5-PCS-3 15

valve type with pilot valve

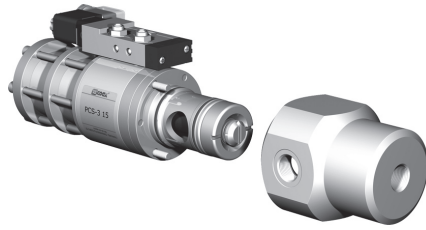

**2/2 way valve** externally controlled  
**pressure range** PN 0-200 bar  
**orifice** DN 15 mm  
**connection** thread/cartridge  
**function** valve normally closed symbol **NC**  
 valve normally open symbol **NO**

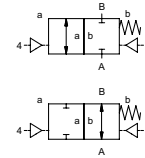

**△** Above stated body materials refer to the valve port connections that get in contact with the media only!

**design** externally controlled, with spring return  
**body materials** ① aluminium ③  
 ① brass ④  
 ② ⑥ stainless steel  
**valve seat** synthetic resin on metal metal on metal  
**seal materials** HNBR FPM, EPDM

**details needed for main valve**

- orifice
- port
- function NC/NO
- operating pressure/Δp
- flow rate
- media
- media temperature
- ambient temperature
- type of actuation

**details needed for pneumatic actuation**

- nominal voltage
- type of protection
- actuation pressure range min/max
- low wattage coil, actuation pressure range 4-7 bar
- pilot valve type

**details needed for hydraulic actuation**

- actuation pressure range min/max
- hydraulic control valve function

**⚠** The valves' technical design is based on media and application requirements. This can lead to deviations from the general specifications shown on the data sheet with regards to the design, sealing materials and characteristics.

**⚠** If order or application specifications are incomplete or imprecise there exists a risk of an incorrect technical design of the valve for the required application. As a consequence, the physical and / or chemical properties of the materials or seals used, may not be suitable for the intended application.

■ specifications not highlighted are standard  
 specifications highlighted in grey are optional

	general specifications	options
<b>ports</b>	PCS-3 without valve body	with valve body thread G 1/2 - G 3/4
<b>function</b>	NC	NO
<b>pressure range</b>	bar 0-200 (see pressure diagram)	NO (see pressure-diagram)
<b>Kv value</b>	m³/h 6,0	
<b>vacuum</b>	leak rate	
<b>pressure-vacuum</b>	P <sub>1</sub> ↔ P <sub>2</sub>	
<b>back pressure</b>	P <sub>2</sub> > P <sub>1</sub>	available upon request
<b>media</b>	gaseous - liquid - highly viscous - gelatinous - pasty - contaminated	
<b>abrasive media</b>		version available
<b>damping</b>	opening closing by throttles on pilot valve	
<b>flow direction</b>	A ↔ B as marked	bi-directional upon request
<b>switching cycles</b>	1/min 300	
<b>switching time</b>	ms opening 100-3000 closing 100-3000	
<b>media temperature</b>	°C direct mounted pilot valve 60	remote mounted pilot valve outside temperature range of media max.150°C
<b>ambient temperature</b>	°C direct mounted pilot valve 50	
<b>flush ports</b>		available
<b>leak ports</b>		inductive
<b>limit switches</b>		
<b>manual override</b>	via 5/2-way pilot valve	
<b>approvals</b>		WAZ
<b>mounting</b>		mounting holes on valve body 2 x M8
<b>weight</b>	kg PCS-3 2,4	PCS-3 3,5
<b>additional equipment</b>		valve body

	electrical specifications	options
<b>nominal voltage</b>	U <sub>n</sub> DC 24V	special voltage upon request
	U <sub>n</sub> AC 230V 50 Hz	special voltage upon request
<b>power consumption</b>	DC 4,8 W	2,5 W
	AC pick up 11,0 VA holding 8,5 VA	
<b>protection</b>	IP 65 (P54) acc. DIN 40 050	
<b>energized duty rating</b>	ED 100%	
<b>connection</b>	plug acc. DIN EN 175301-803 form B, 4 positions x 90° / wire diameter 6-8 mm	
<b>additional equipment</b>	illuminated plug with varistor	connector acc. VDMA
<b>optional</b>	M12x1 connector acc. DESINA	
<b>max. temperature</b>	media 60°C	
	ambient 50°C	
<b>explosion proof</b>	EEx m II T5 nominal voltage U <sub>n</sub>	direct current 24 V 3,25 W
	power consumption	alternating current 230 V 50 Hz 2,90 W

	pneumatic specifications	options
<b>actuation pressure range</b>	bar 4-10	
<b>air consumption</b>	cm³/stroke PCS-3 58	
<b>cycle speed</b>	main valve speed variable by throttles on pilot valve	
<b>control</b>	by 5/2-way pilot valve	
<b>actuator ports</b>	2/4 G 1/8	

	hydraulic specifications	options
<b>actuation pressure range</b>	bar 10-30	>30 bar upon request
<b>by media</b>		
<b>control</b>	preferably 4/2-way control valve	
<b>actuator ports</b>	X/Y G 1/4 via adapter	NPT 1/4 via adapter

# type PCS-3 15

function: **NC**  
closed when not energized

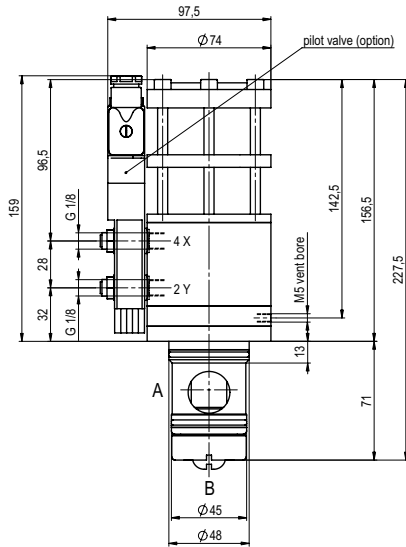

## drilling design for cartridge

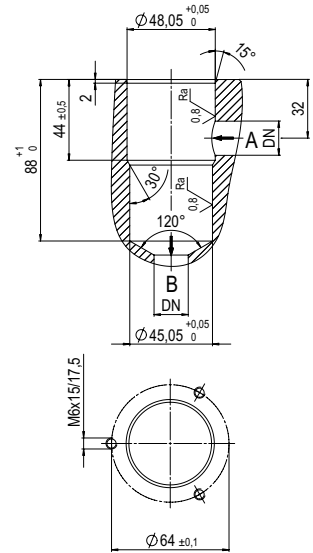

# type PCS-3 15

function: **NO**  
open when not energized

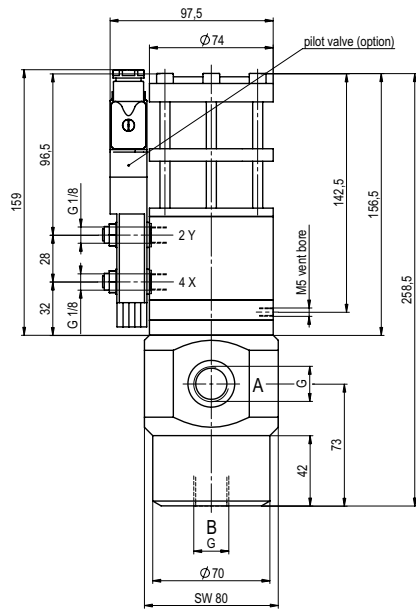

## pressure-diagram

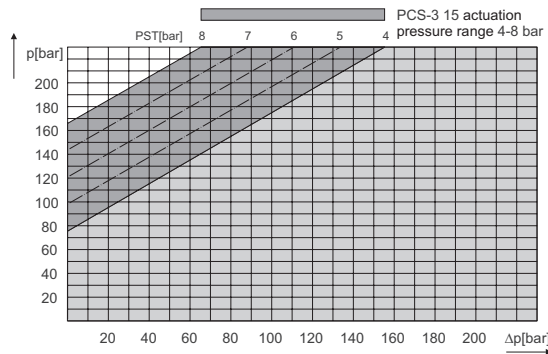

## pneumatic actuation (separately)

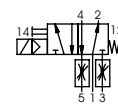

5/2-way-pilot valve  
flow rate 350 l/min  
pressure range 3-10 bar G 1/8

The application-specific layout relating to temperature, pressure conditions, switching behavior, media and its consistency may restrict the range of use or necessitate relevant modifications to materials used and seal arrangements.  
Rights reserved to make technical alterations • Not responsible for printing errors • Detailed drawings can be obtained upon request